



 **User Manual**

VYPER

Dear customer,

Thank you for choosing **ANYCUBIC** products.

Maybe you are familiar with 3D printing technology or have purchased **ANYCUBIC** printers before, we still highly recommend that you read this manual carefully. The installation techniques and precautions in this manual can help you avoid any unnecessary damage or frustration.

More information please refer to :

1. <https://www.anycubic.com/>

ANYCUBIC website provides software, videos, models, after-sale service, etc.

Please go to our website to report any issue and we are likely to answer or solve all the questions for you!

2. Facebook page and Youtube channel as shown below.



ANYCUBIC website



Facebook page



Youtube channel

Team **ANYCUBIC**

Contents

Safety Instruction	4
Technical Specification	5
Packing List	6
Product Overview	7
Menu Directory	8
Installation	13
Leveling	20
Load Filament	22
Print Model	25
Driver Installation	28
Introduction to Slicing Software	31
Cura installation	31
Machine settings	33
Import the configuration file	36
Manipulate 3D model in Cura	38
Slice and preview	41
Print online	41
Print offline	43
Resume from Outage	44
Maintenance	45
Troubleshooting	46

Safety Instruction

Always follow the safety instructions during assembly and usage, to avoid any unnecessary damage to the machine or individual injury



Please contact our customer service first if you have any issue after receiving the products.



Be cautious when using the scraper. Never direct the scraper towards your hand.



In case of emergency, please immediately cut off the power of **ANYCUBIC** 3D printer and contact the technical support.



ANYCUBIC 3D printer includes moving parts that can cause injury.



It is recommended to wear protection glasses when printed models to avoid small particles contacting eyes.



Keep the **ANYCUBIC** 3D printer and its accessories out of the reach of children.



Vapors or fumes may be irritating at operating temperature. Always use the **ANYCUBIC** 3D printer in an open and well ventilated area.



ANYCUBIC 3D printer must not be exposed to water or rain.



ANYCUBIC 3D printer is designed to be used within ambient temperature ranging 8°C-40°C, and humidity ranging 20%-50%. Working outside those limits may result in low quality printing.



Do not disassemble **ANYCUBIC** 3D printer, please contact technical support if you have any question.

Technical Specification

Printing

Technology:	FDM (Fused Deposition Modeling)
Build Size:	245×245×260 (mm ³)
Print accuracy:	±0.1 mm
Positioning Accuracy:	X/Y 0.0125mm, Z 0.002mm
Extruder Quantity:	Single
Nozzle Diameter:	0.4 mm
Print Speed:	20~100mm/s (suggested 80mm/s)
Supported Materials:	ABS, PLA, TPU, PETG, Wood

Temperature

Ambient Operating Temperature:	8°C - 40°C
Operational Heated Bed Temperature:	max 110°C
Operational Extruder Temperature:	max 260°C

Software

Slicer Software:	Cura
Software Input Formats:	.STL, .OBJ, .AMF
Software Output Formats:	GCode
Connectivity:	Memory card; Data cable(expert users only)

Electrical











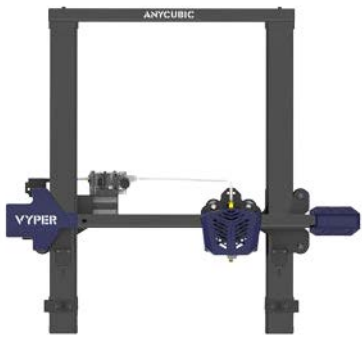



Input rating:	110V/220V AC, 50/60Hz
Output rating:	24V/14.6A (350W)

Physical Dimensions

Printer Dimensions:	508mm×457mm×516mm
Net Weight:	~10kg



Packing List

			
<p style="text-align: center;">Frame</p>		<p style="text-align: center;">Base</p>	
			
<p>Filament holder</p>	<p>Display screen</p>	<p>M5x14 screw (3PCS)</p>	<p>Washer (4PCS) M5x45 screw (4PCS)</p>
			
<p>Power cord</p>	<p>Data cable</p>	<p>Nozzle</p>	<p>Assembly instruction</p>
			
<p>Filament</p>	<p>After-sale service card</p>	<p>Memory card</p>	<p>Card reader</p>
			
<p style="text-align: center;">Tool kit</p>			

Product Overview

Front view

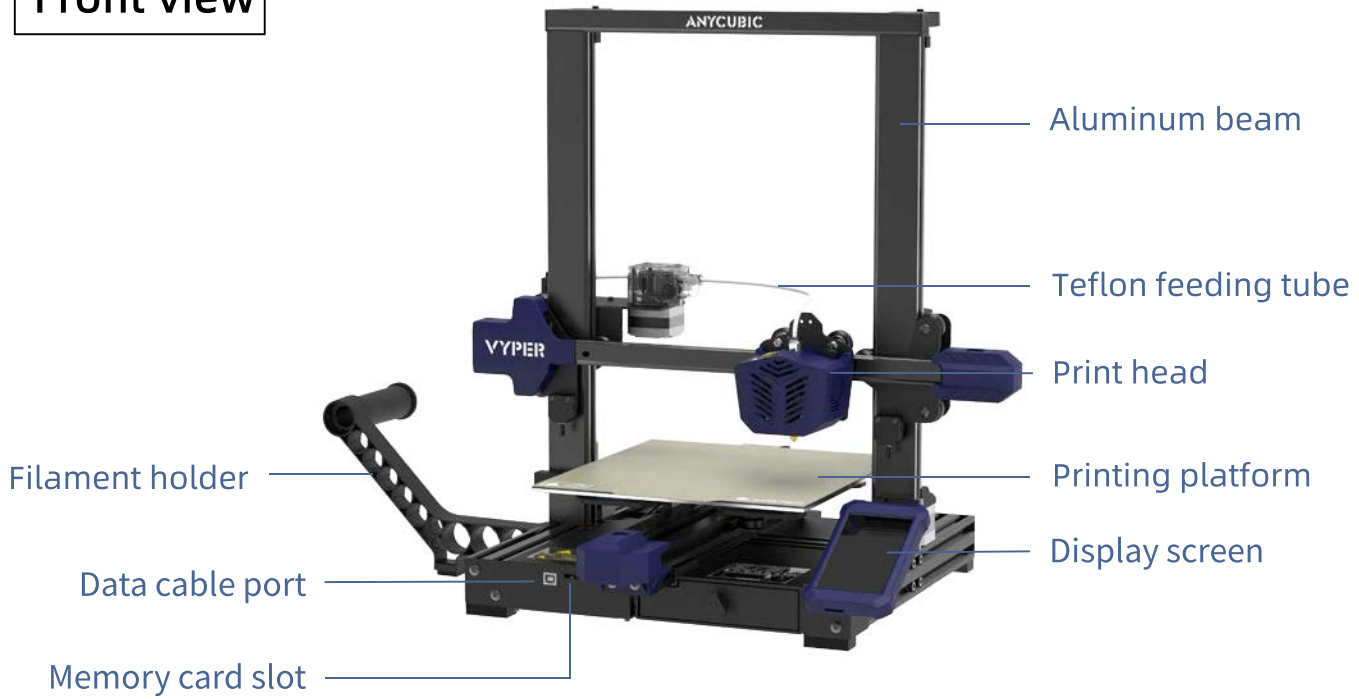

Back view

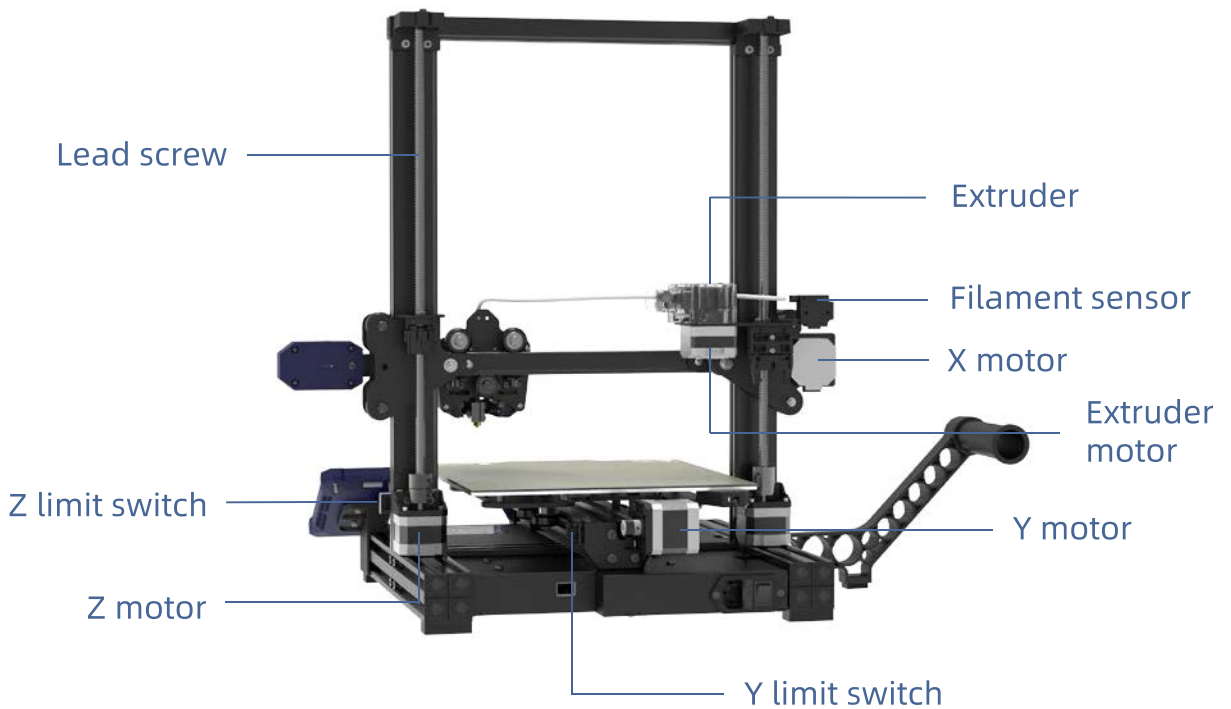

Menu Directory

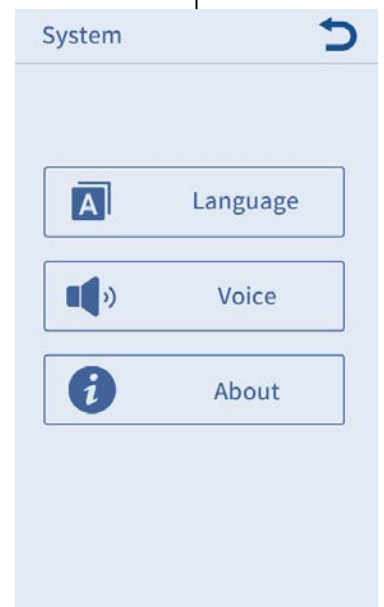
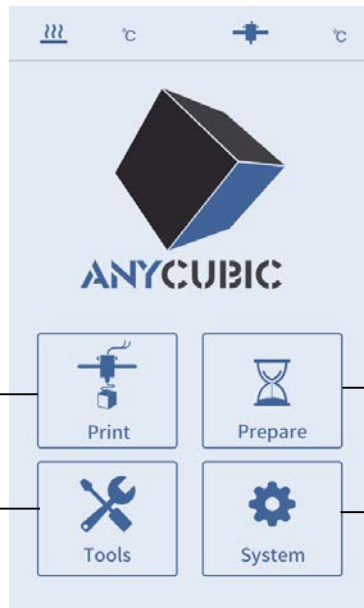
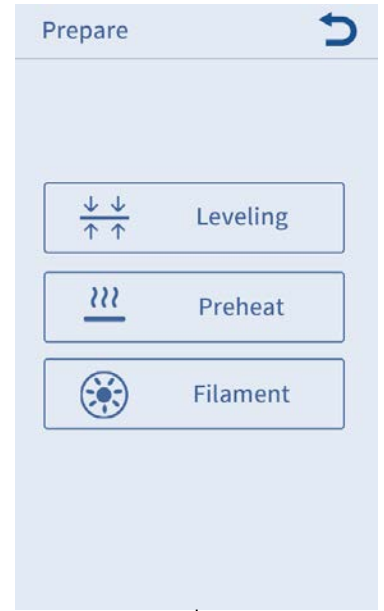

Menu Directory

Print

File List

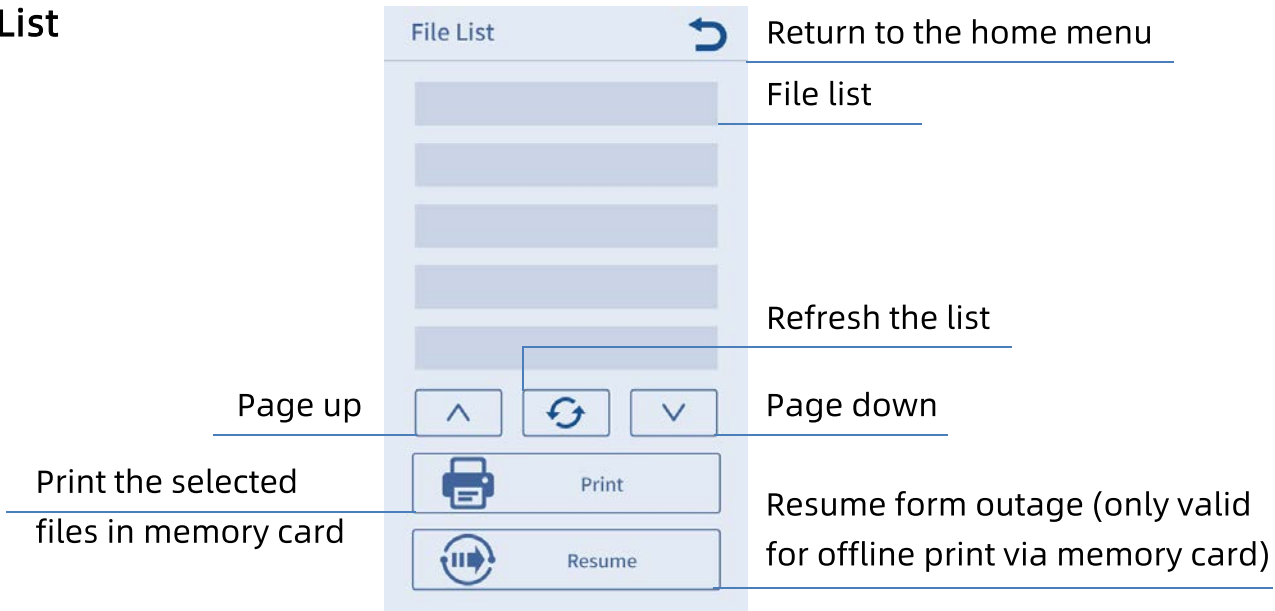

Prepare

Leveling

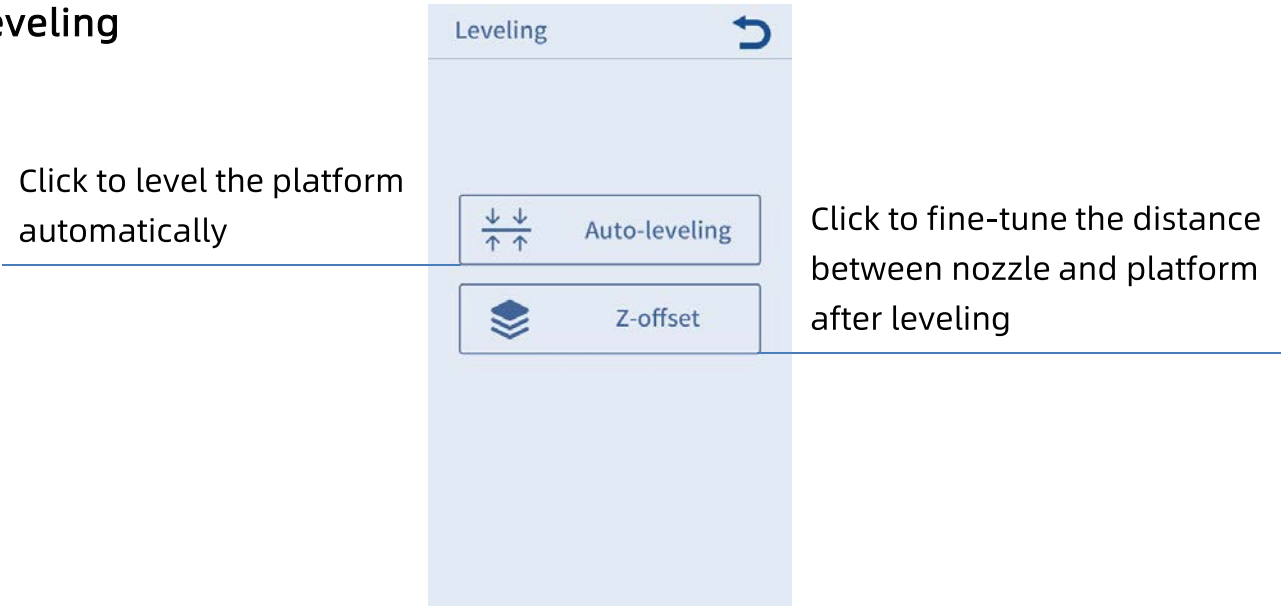

Note: In most cases, there is no need to operate the Z-offset after auto-leveling.

Menu Directory

Preheat

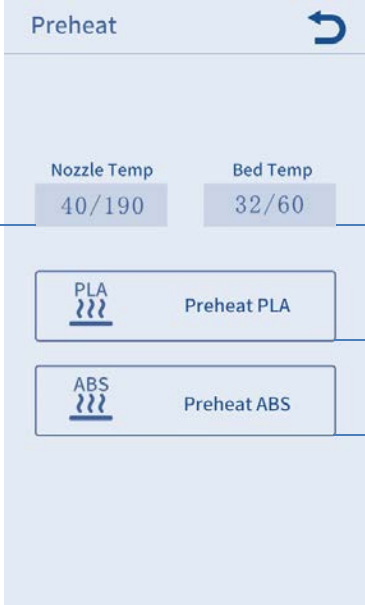

The screenshot shows the 'Preheat' menu with a back arrow in the top right. It features two temperature displays: 'Nozzle Temp' showing 40/190 and 'Bed Temp' showing 32/60. Below these are two buttons: 'Preheat PLA' with a PLA icon and 'Preheat ABS' with an ABS icon.

Nozzle Temp/Target Temp

Heated bed Temp/Target Temp

Click to preheat PLA

Click to preheat ABS

Filament



The screenshot shows the 'Filament' menu with a back arrow in the top right. It features an 'EO Temp' display showing 23/230. Below this are three buttons: 'Stop' with a square icon, 'Filament In' with a right-pointing arrow icon, and 'Filament Remove' with a left-pointing arrow icon.

Automatically heating to the setting temperature for filament in

Nozzle Temp/Target Temp

Automatically heating to the setting temperature for filament remove

Stop to filament in/remove

Menu Directory

Tools

Move Axis

Move Axis Return

Unit mm 0.1 1.0 10

Move forward Y axis Move up Z axis

Move left X axis Move right X axis

Move backward Y axis Move down Z axis

Home All Click to home all

Temperature

Temperature Return

Current heated bed Temp Click to set heated bed Temp (30-110°C)

Reduce heated bed Temp Raise heated bed Temp

Current nozzle Temp Click to set nozzle Temp (170-260°C)

Reduce nozzle Temp Raise nozzle Temp

Cut off the power to hot-end and heated bed Cooling OK

Menu Directory

Speed

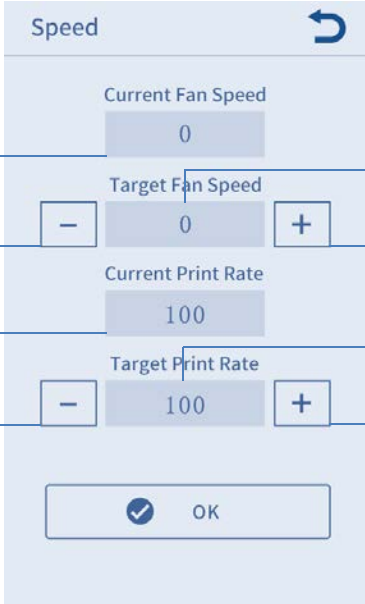

The screenshot shows a 'Speed' menu with a refresh icon in the top right. It contains four rows of controls:

- Current fan speed:** A numeric field showing '0'. A label 'Current Fan Speed' is above it. A description 'Click to set fan speed (0-100%)' is to the right.
- Decrease fan speed:** A '-' button, a numeric field showing '0', and a '+' button. A label 'Target Fan Speed' is above the field. A description 'Increase fan speed' is to the right.
- Current print rate:** A numeric field showing '100'. A label 'Current Print Rate' is above it. A description 'Click to set print rate (0-100%)' is to the right.
- Decrease print rate:** A '-' button, a numeric field showing '100', and a '+' button. A label 'Target Print Rate' is above the field. A description 'Increase print rate' is to the right.

At the bottom of the menu is an 'OK' button with a checkmark icon.

Light: Turn on/off the light of the print head

Motor: Disable all motors (only valid when machine is not printing)

System

Language: Change language (English/Chinese)

Voice: Turn on/off the screen sound

About: Information about the product

Installation

1. Be cautious during assembly as some parts may have sharp edges.
2. It is suggested to use a flat desktop and place the parts in an orderly manner for quick assembly.
3. The color of some parts may be different from what in the manual, but the assembly is the same.
4. Firmware has been pre-uploaded to the motherboard. After completing the assembly, please level the platform and load the filament then you could start the first test print.

Note: Every unit of the printer has been inspected and tested for printing. Therefore, in some cases, there might be very small marks left on the print head or on the heated bed. Those will not affect the printing quality and those mean the printer has been tested for the quality. The aluminum beam has slight scratches or slight unevenness on the platform, which is normal if it does not affect normal printing. Thank you very much for your kind understanding.

Team **ANYCUBIC**

Installation

Pre-installation check:

1. Please cut off the following 4 zip ties before turning on the machine.



Pre-installation check: 2. D-shape wheels of the base may be loosened due to transportation, please check it after unpacking. Place the base on a flat desktop. Shake the platform to confirm whether the printing platform is shaking up and down. If so, please tighten the hexagonal pillars of the D-shape wheels on the right under the platform.

② Tighten the hexagonal pillar clockwise with a 10mm open end wrench.

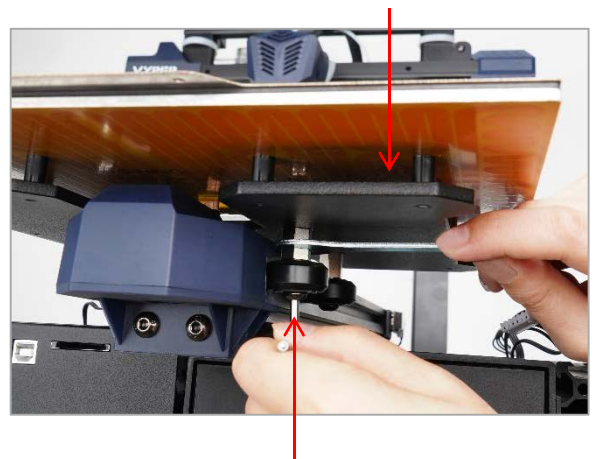
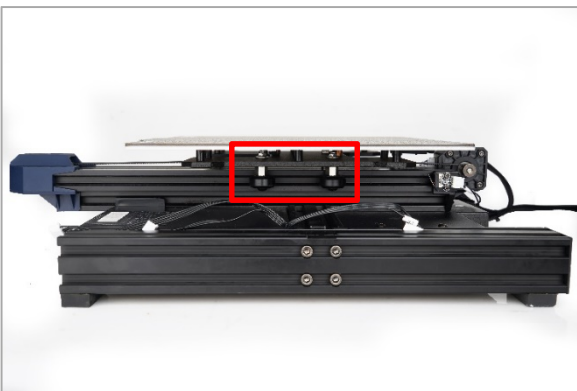

① Fix the nut with a hex key.

Installation

* Take out the tools from the toolbox on the left front of the base to install the machine.

1. Install frame

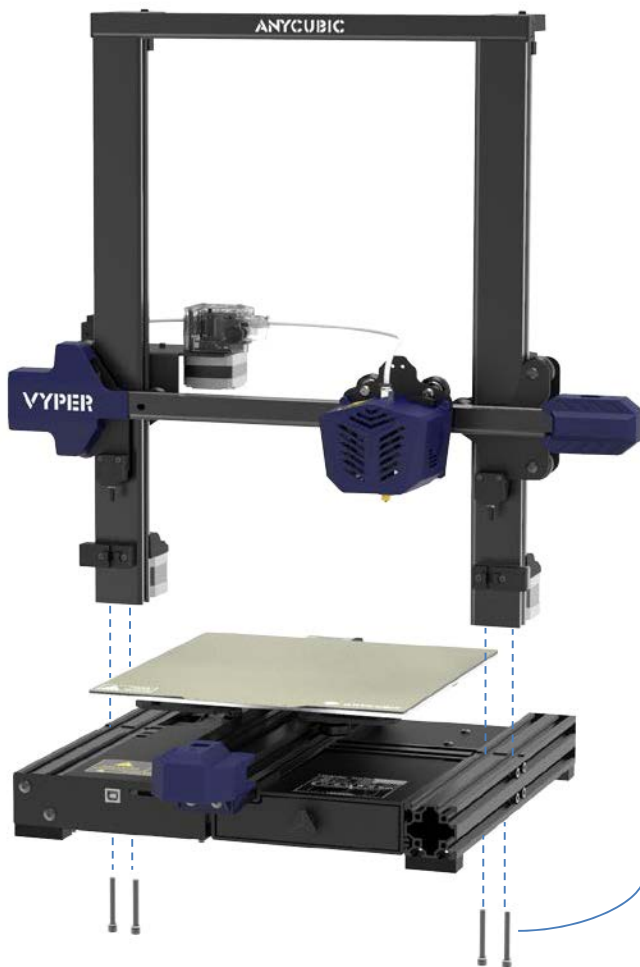

Z aluminum beams must align with the groove of the base aluminum beam.



Installation

2. Install display screen

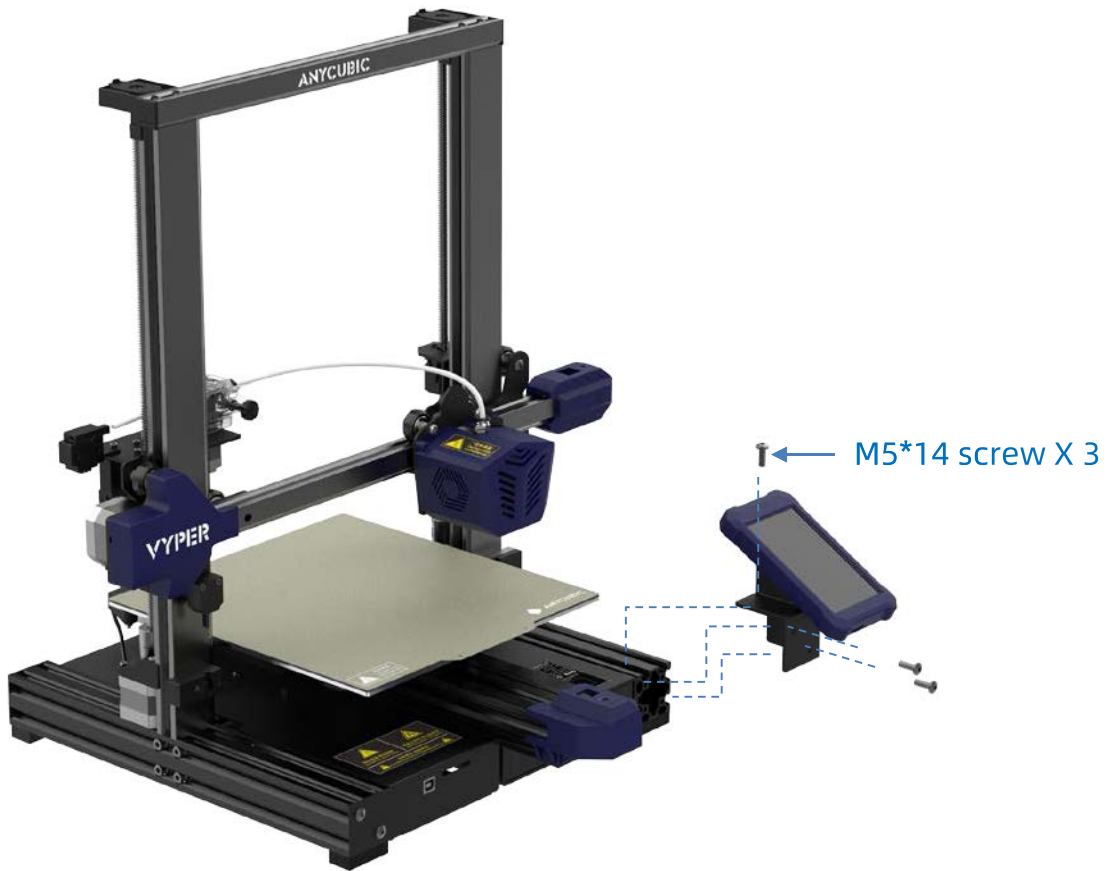

3. Install filament holder



Installation

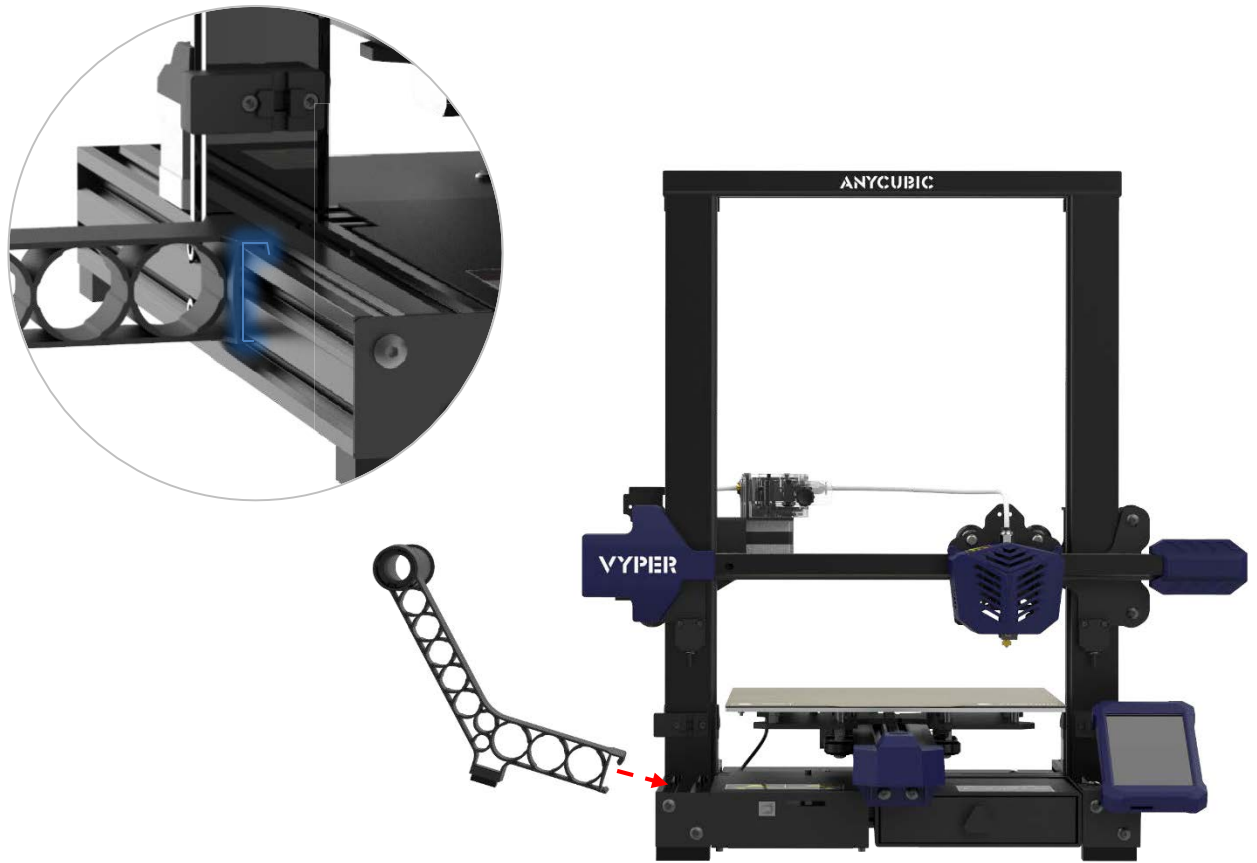

4. Insert the teflon tubing into the extruder.



Installation

5. Wiring: connect all these wires to their corresponding ports by the label respectively.

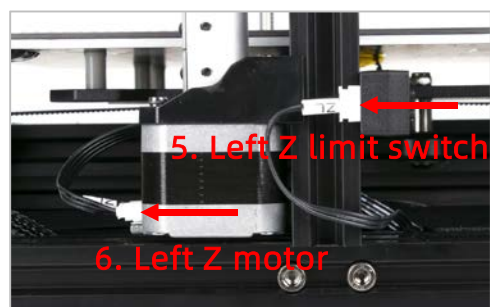
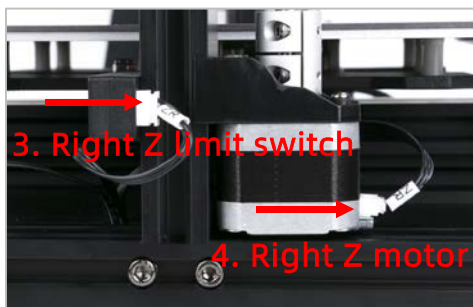
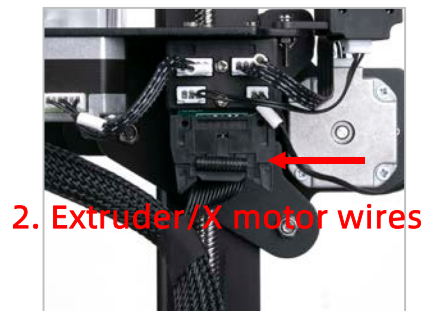
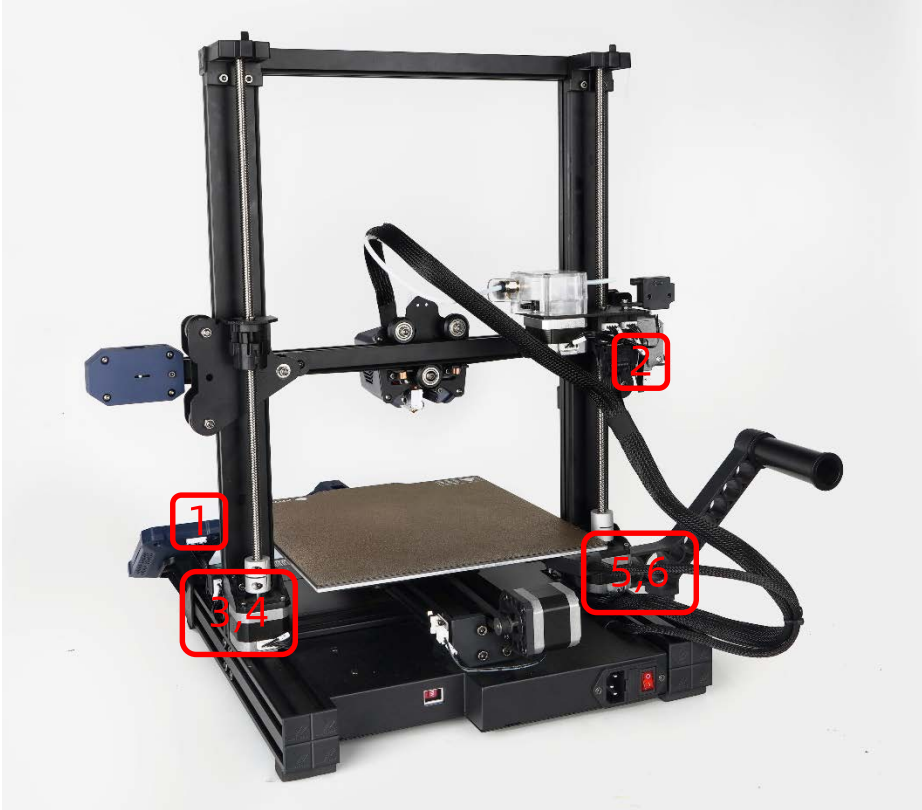

Installation

6. Use zip ties to bind the print head wire harness and the Teflon tube together.



Leveling

It is essential to level the print platform of a 3D printer. Once leveled, it is not necessary to level every time before each printing. Please follow the procedures below:

1. Select correct voltage mode of the power box according to your local voltage ratings (110V/220V) before plug in. The default setting is 220V.



In some cases, 220V labeled as "230" , 110V labeled as "115"

2. Click "Prepare"→ "Leveling"→ "Auto-leveling", and the interface as shown below will pop up, click "OK". Then the machine will probe 16 spots on the platform automatically.

(Note: Before leveling, please ensure that the nozzle is clean and free of foreign matter to avoid affecting the leveling effect.)

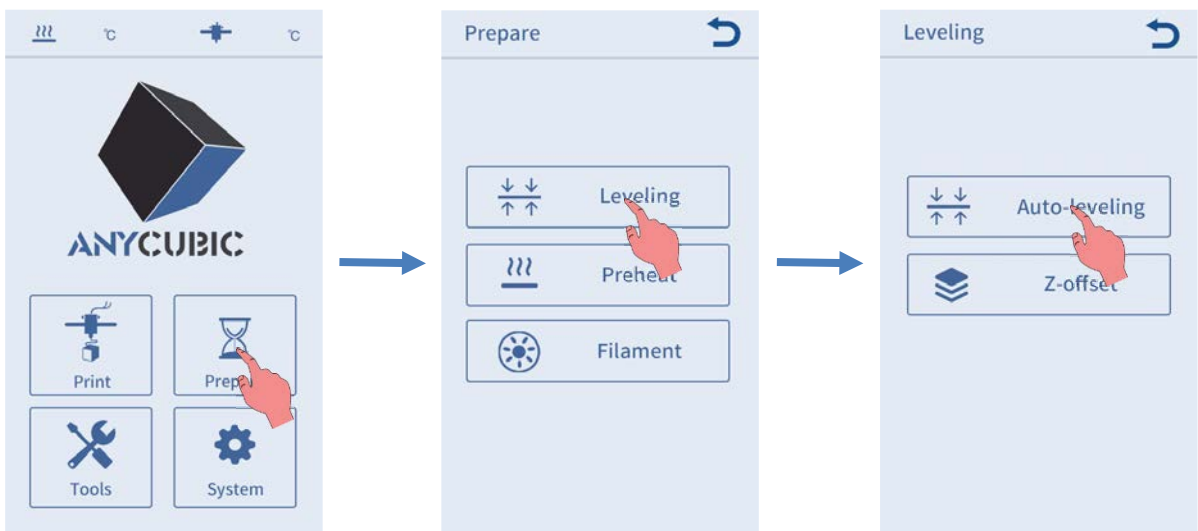

Leveling

The probing will start, please
confirm to continue!

OK

Cancel



Load Filament

1. Return to the main menu, click “Prepare”→ “Filament”→ “Filament In”, and the interface as shown below will pop up, click “Ok”.

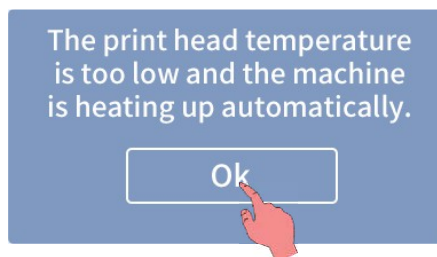
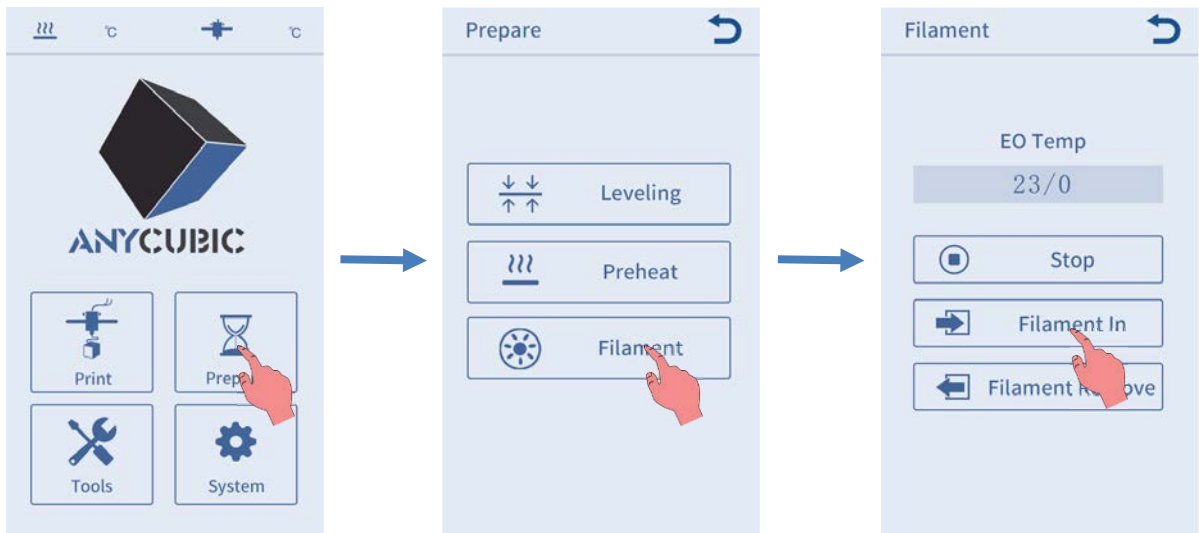

2. Straighten the end of filament, and place the filament on the filament holder (**Please note the feeding direction of filament**). Then pass the filament through filament sensor, and insert it to the extruder till the gear. Now, wait for the nozzle reaches to the target temperature as shown on the display screen.

Please straighten the end of filament before insert it.



Load Filament

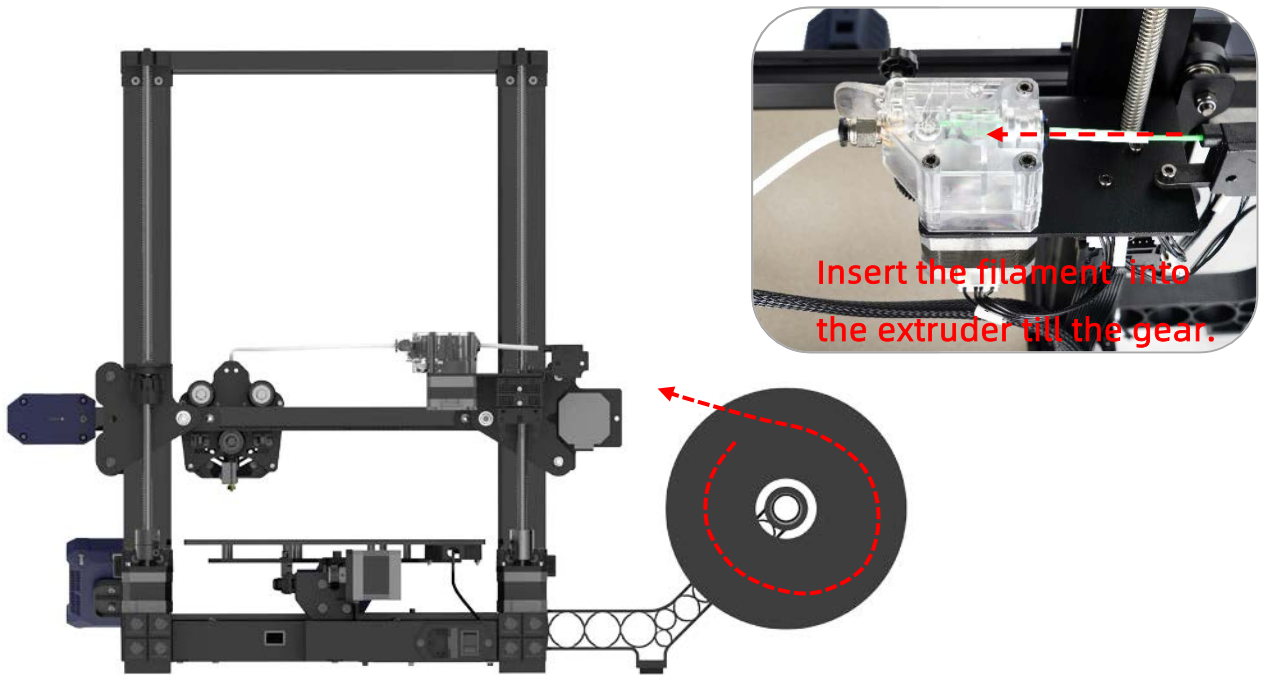

3. When the nozzle reaches to the target temperature, click "Filament In" again. The filament would be automatically fed in by the extruder and it would be melted through the nozzle. Now, click "Stop". You may use tweezers to clean the filament residue on the nozzle tip.

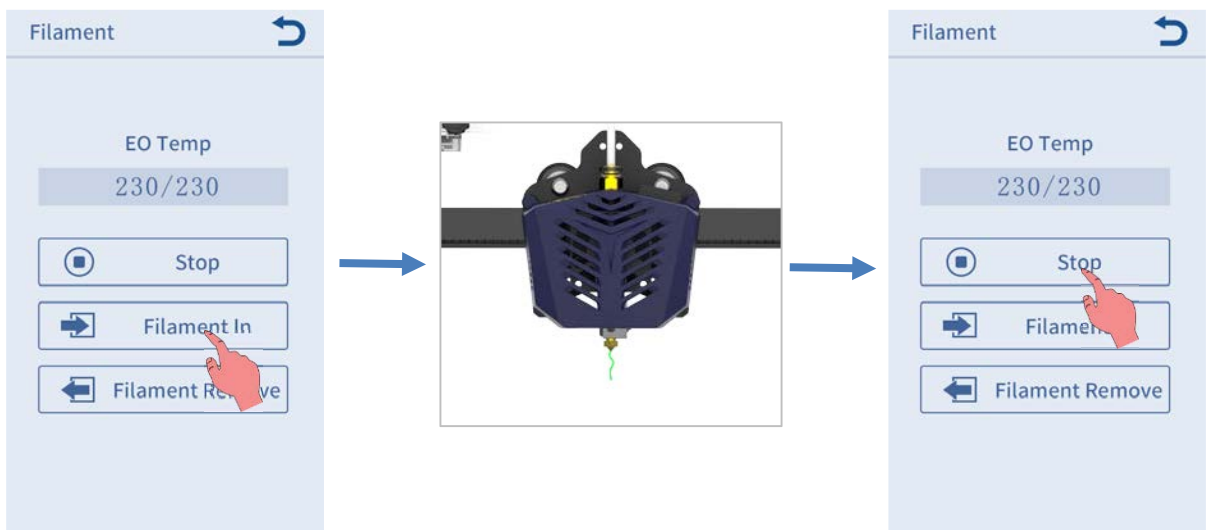

Load Filament

Note: During feeding, if the melted filament is not smooth or too thin, please adjust the extrusion force by rotating the knob as shown below.



If the melted filament is not smooth, please increase the extrusion force by rotating clockwise.



If the melted filament is too thin, please reduce the extrusion force by rotating counterclockwise.



Note: The better distance for extruding filament is about 18 mm. You may adjust the distance of the screw for the different filament.

Print Model

1. Insert the memory card into the memory card slot. The printable test file has been saved to the memory card.



2. On main menu, Click "Print" to enter the file list. Click the "owl.gcode" and click "Print" for the test printing.

(owl, author: etotheipi, www.thingiverse.com)



Printer starts printing when temperature reaching to target value.
(Note: The nozzle will be start heating after the heated bed reaches to target temperature first.)

Print Model

When printing the first layer, you can click "Settings" -> "Z-offset" to fine-tune the height of the Z axis according to the adhesion between the filament and the platform. **In most cases, there is no need to adjust Z-offset after auto-leveling.**

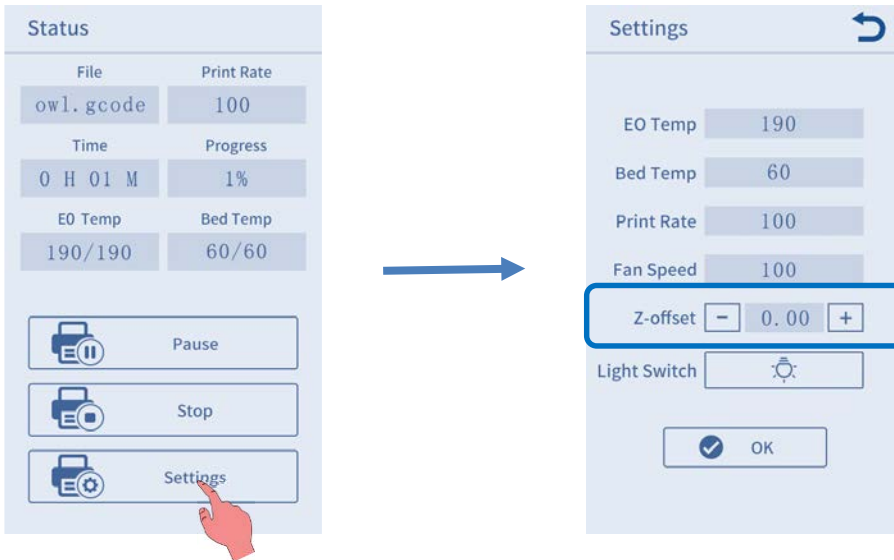

Note: After adjusting the Z-offset, you need to click "OK" to make it valid for future printing. If you click the return icon only after adjustment, the Z-offset is valid for the current printing.

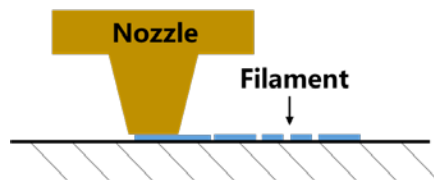

Nozzle too low, lack of extrusion, the nozzle rub against the platform. Click "Z offset +" to rise the nozzle.

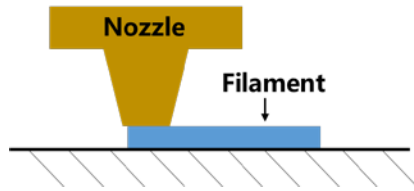

Proper nozzle height, good extrusion and adhesion.

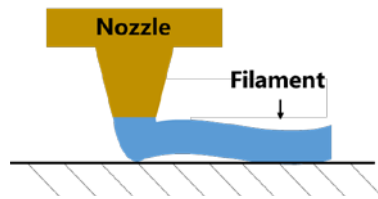

Nozzle too high, large gap, filaments do not even adhere to the platform. Click "Z offset -" to lower the nozzle.

3. Nozzle and platform are still in high temperature when printing is finished, Please be cautious to avoid injury.

Driver Installation

There are two operational modes for Vyper : print offline and print online.

Print offline: As shown previously, insert memory card to memory card slot, click “Print” on main menu and print a selected file (GCode files ONLY).

Print online: Install CH340 driver to bridge PC and machine, and install Cura for slicing and control the machine to print via data cable.

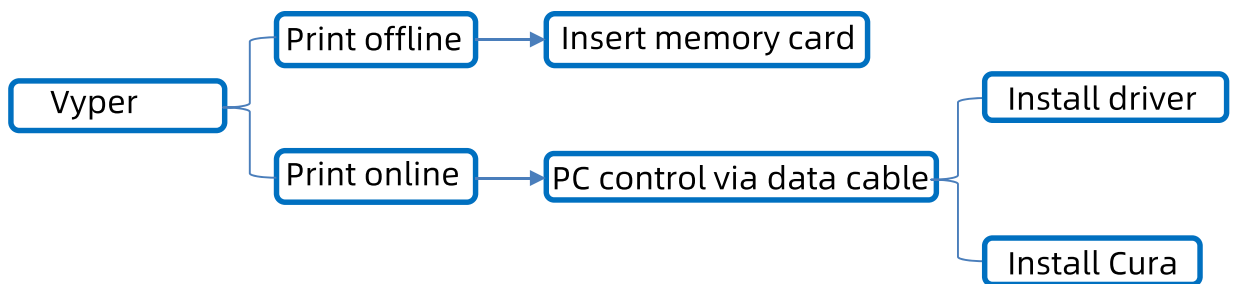

It is suggested to use **Print Offline** mode to minimize the noisy signal via data cable.

How to install the software to enable PC control (print online).

First, turn on the machine, connect the printer (data cable port) and your PC via data cable. Vyper uses CH340 chip for communication. The CH340 driver may not be installed automatically, so it is required to check that. Right click “This PC” → “Properties” → “Device manager”, if there is an exclamation mark as shown below, it needs to be installed manually.

Driver Installation

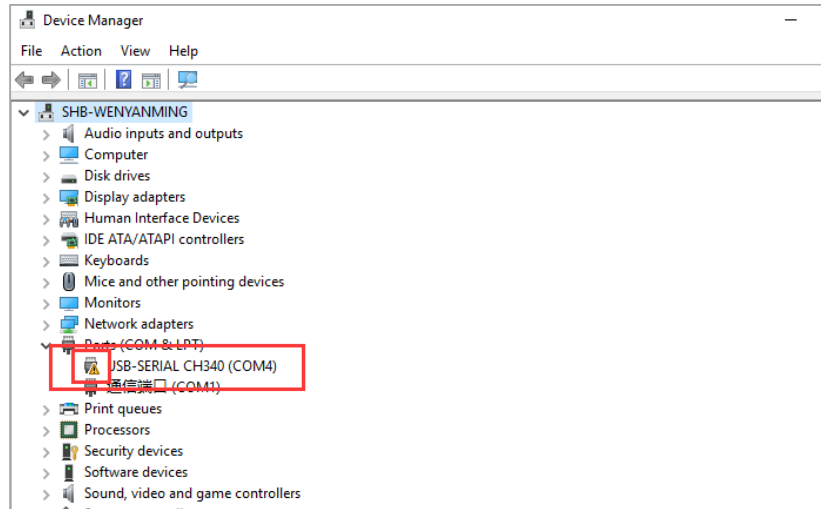

CH340 driver file are located in the memory card (or visit our website to download). "Files_English_Vyper" → "Driver_CH341" → "Windows" (CH341 driver file is suitable for CH340 chip).
Double click "CH341SerSetup.exe" to install it.

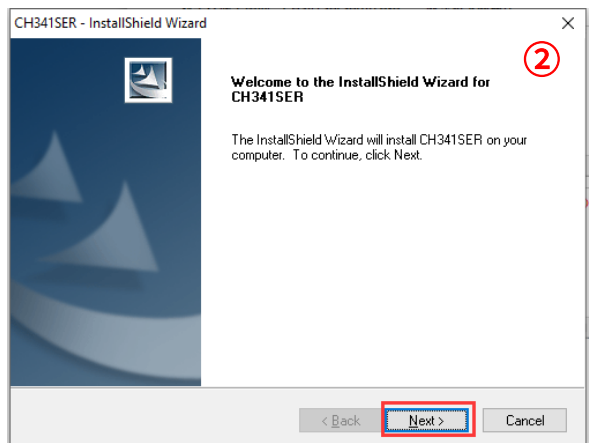
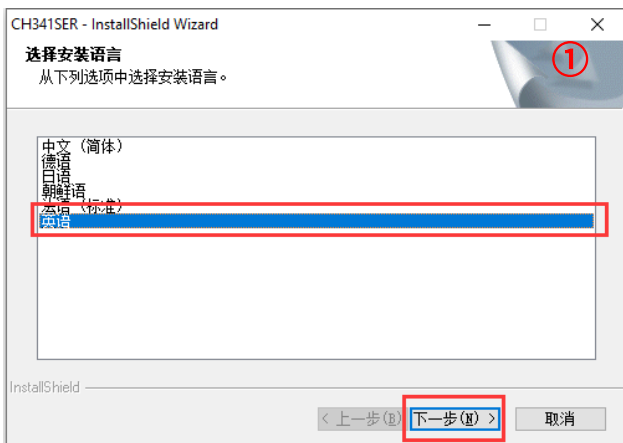

Driver Installation

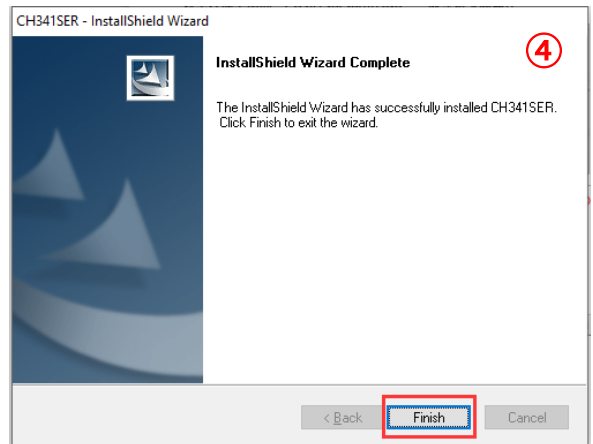
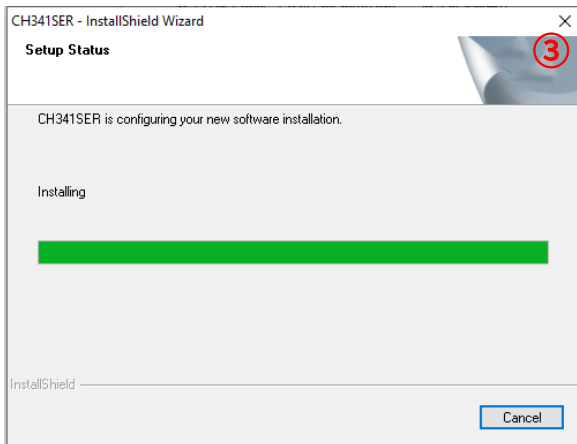

Right click "This PC" → "Properties" → "Device manager" to check, you can see that the exclamation mark has disappeared.

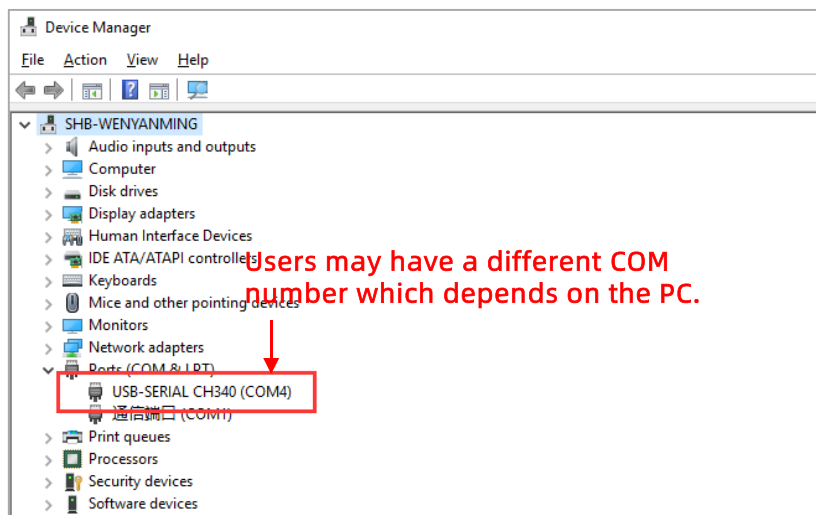

Introduction to Slicing Software

Introduction of slicing software: ①Cura installation, ②Machine settings, ③Import the configuration file , ④ Manipulate 3D model in Cura, ⑤Slice and preview, ⑥Print online, ⑦Print offline

1. Cura installation

3D printer reads Gcode file and prints. It is necessary to convert 3D files (such as stl file) into Gcode files for machine to recognize. Software that convert 3D files into Gcode files is called slicing software.

Ultimaker_Cura-4.2.1-win64 is used for example here (Users may use their own slicing software). It is located in memory card→

“ Files_English_Vyper”→ “ Cura”→ “ Windows”. Double click

“Ultimaker_Cura-4.2.1-win64.exe”, and follow the steps as shown below.

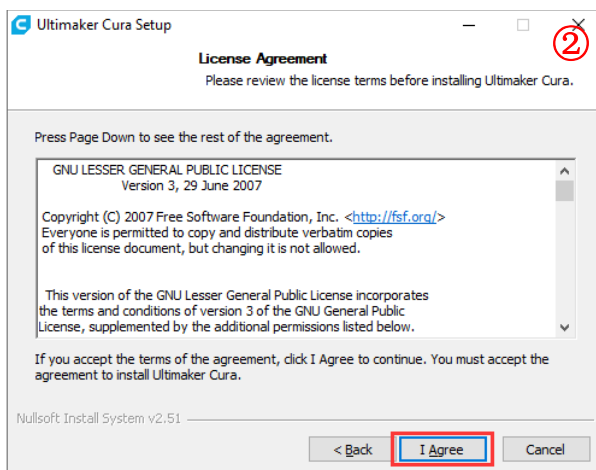
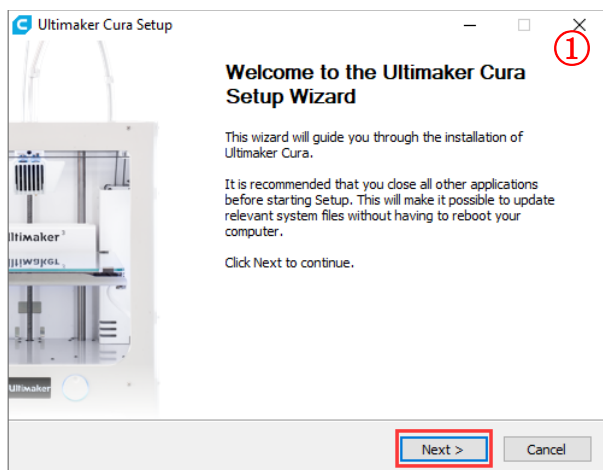

Introduction to Slicing Software

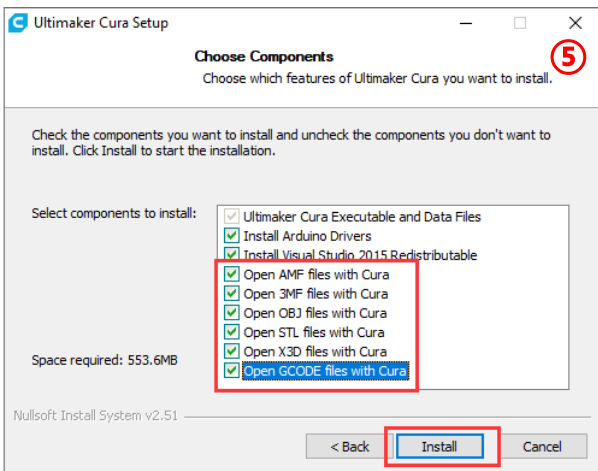
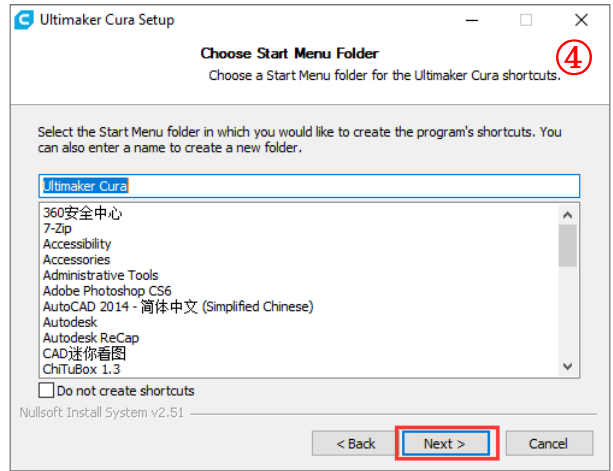
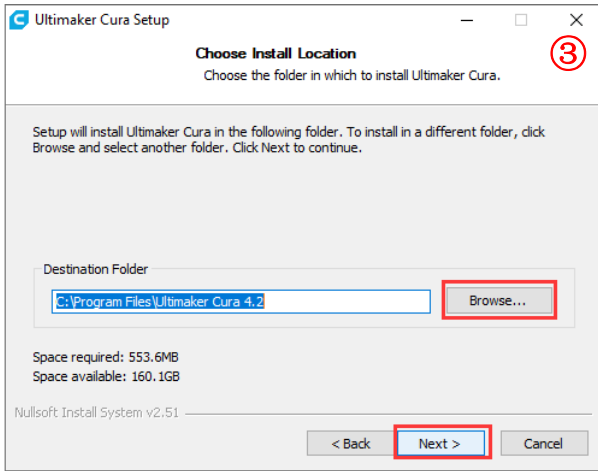

Note: Printing online requires the installation of a driver, as shown below. If you don't print online, you don't need to install it.

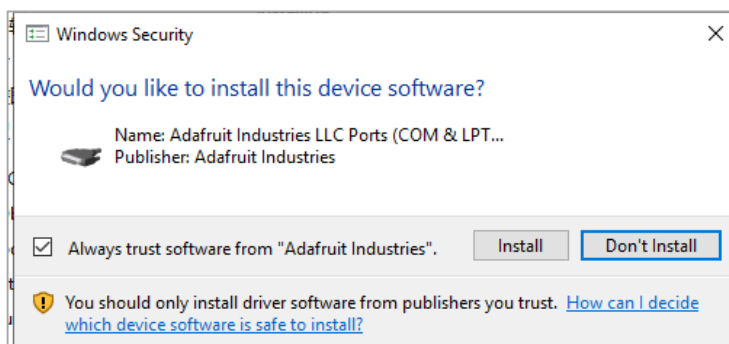

Introduction to Slicing Software

2. Machine settings

Upon completion of installation, the first launch of the software will display the following welcome screen. Click "Get started" to start the machine settings.

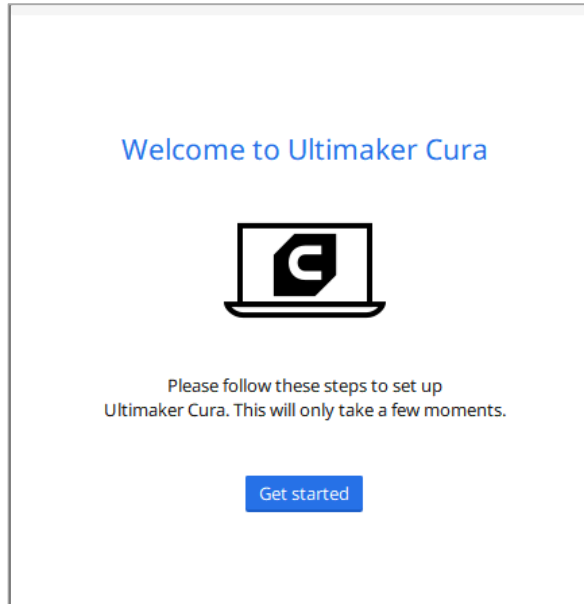

① **User Agreement**

Disclaimer by Ultimaker

Please read this disclaimer carefully.

Except when otherwise stated in writing, Ultimaker provides any Ultimaker software or third party software "As is" without warranty of any kind. The entire risk as to the quality and performance of Ultimaker software is with you.

Unless required by applicable law or agreed to in writing, in no event will Ultimaker be liable to you for damages, including any general, special, incidental, or consequential damages arising out of the use or inability to use any Ultimaker software or third party software.

[Decline and close](#) [Agree](#)

② **What's new in Ultimaker Cura**

4.2.0

Orthographic view.
When preparing prints, professional users wanted more control over the 3D view type, so this version introduces an orthographic view, which is the same view type used by most professional CAD software packages. Find the orthographic view in View > Camera view > Orthographic, and compare the dimensions of your model to your CAD design with ease.

Object list.
Easily identify corresponding filenames and models with this new popup list. Click a model in the viewport and its filename will highlight, or click a filename in the list and the corresponding model will highlight. The open or hidden state

[Next](#)

Introduction to Slicing Software

③ Help us to improve Ultimaker Cura

Ultimaker Cura collects anonymous data to improve print quality and user experience, including:

Machine types



Material usage



Number of slices



Print settings

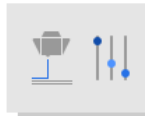

Data collected by Ultimaker Cura will not contain any personal information. [More information](#)

Next

④ Add a printer

Add a networked printer

There is no printer found over your network.

Refresh Add printer by IP Troubleshooting

Add a non-networked printer

Next

⑤ Add a printer

Add a networked printer

Add a non-networked printer

- ▼ Anycubic
 - Anycubic 4Max
 - Anycubic Chiron
 - Anycubic i3 Mega
- > Ateam Ventures Co. Ltd.
- > BEEVERYCREATIVE
- > BFB
- > BIBO
- > BQ
- > Builder
- > Cocoon Create

Printer name Anycubic i3 Mega

Next

⑥ Ultimaker Cloud



The next generation 3D printing workflow

- Send print jobs to Ultimaker printers outside your local network
- Store your Ultimaker Cura settings in the cloud for use anywhere
- Get exclusive access to print profiles from leading brands

Create an account Sign in

Finish

According to the wizard, we have selected the "Anycubic i3 Mega" model. Now, we will set the model parameters of Vyper based on that model.

Introduction to Slicing Software

(1) Click "Manage printers", as shown below.

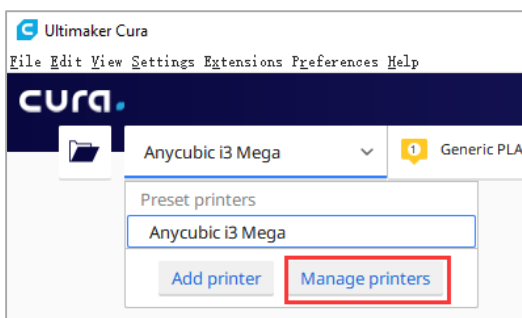

(2) Click "rename" to change the machine name to "Anycubic Vyper", and then click "Machine Settings".

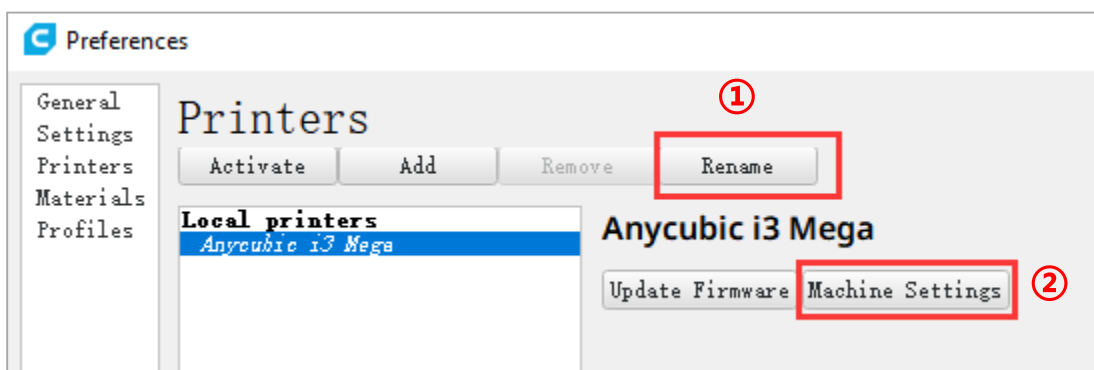

(3) Modify the "XYZ" parameters as 250, 255 and 265 respectively on the "Machine Settings" page, as shown below.

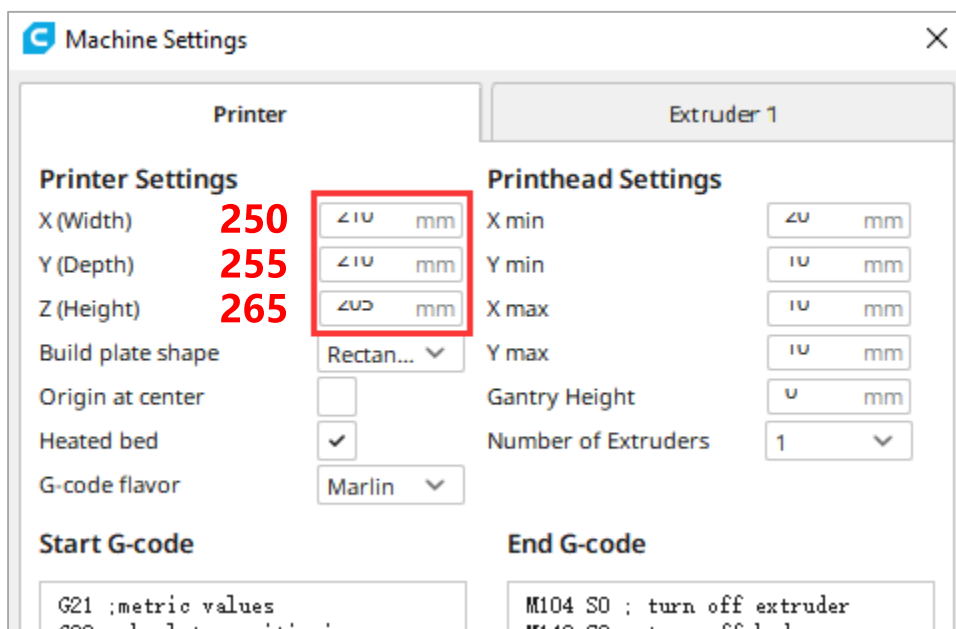

Introduction to Slicing Software

3. Import the configuration file

After continuous testing, we provided users the suggested printing parameters of different filaments for Vyper, and the user could directly import the parameter files in the memory card to the software.

(1) Click "Settings"- "Configure setting visibility...", and then check "Check all" to make all settings visible.

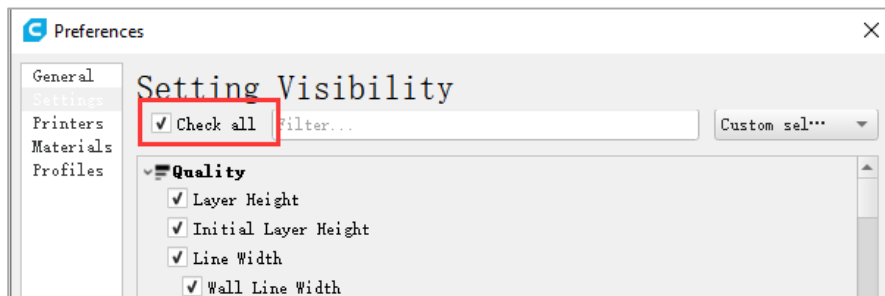
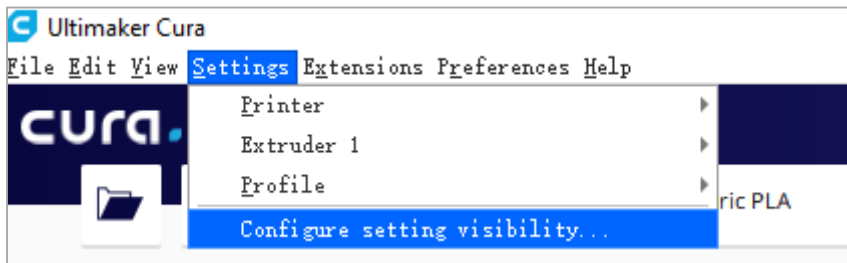

(2) Click "profile" on the left, and then click "import" to open the "import profile" dialog box, then select the "Anycubic Vyper-PLA. curaprofile" or other files (file path: memory card → "File _ English _Vyper"), and click "open". After successful import, the following success prompt will pop up.

Introduction to Slicing Software

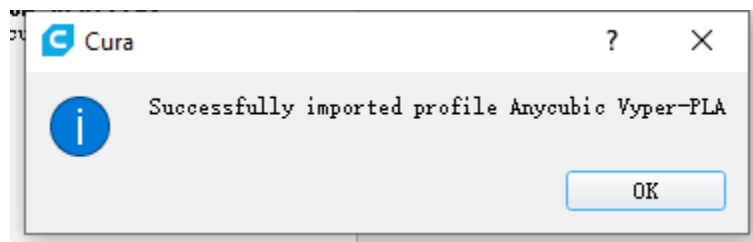
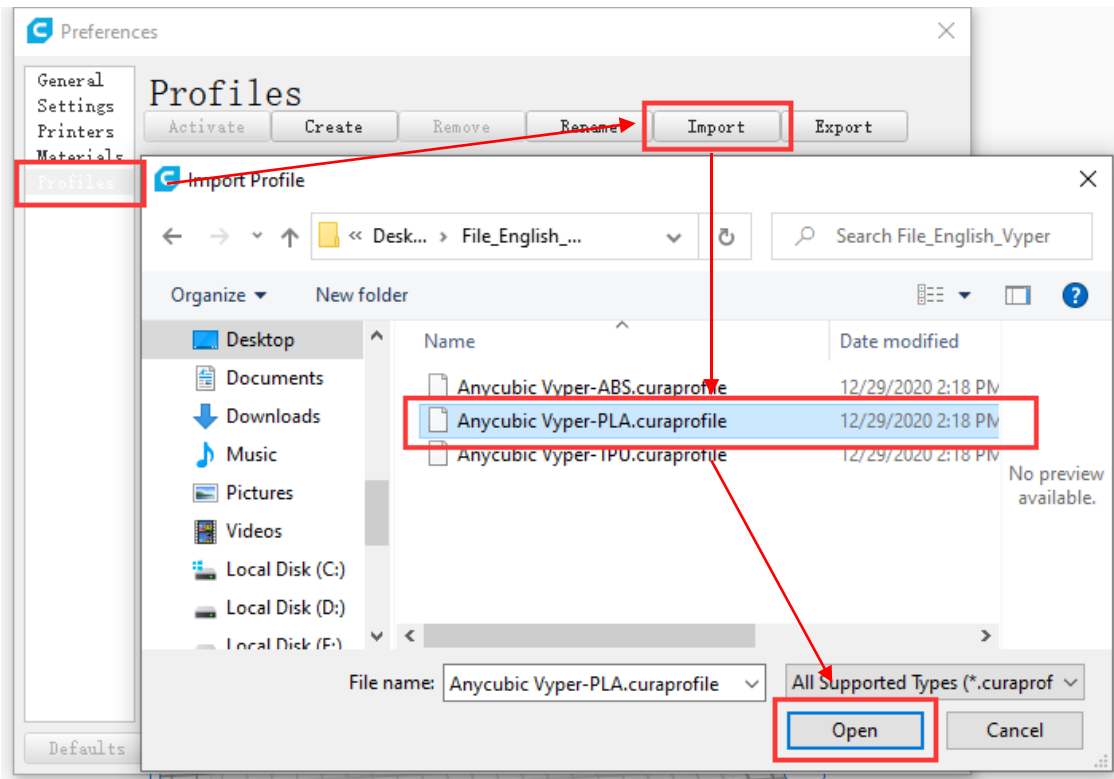

(3) Select the configuration file that you just imported, and then click “Activate”.

Introduction to Slicing Software

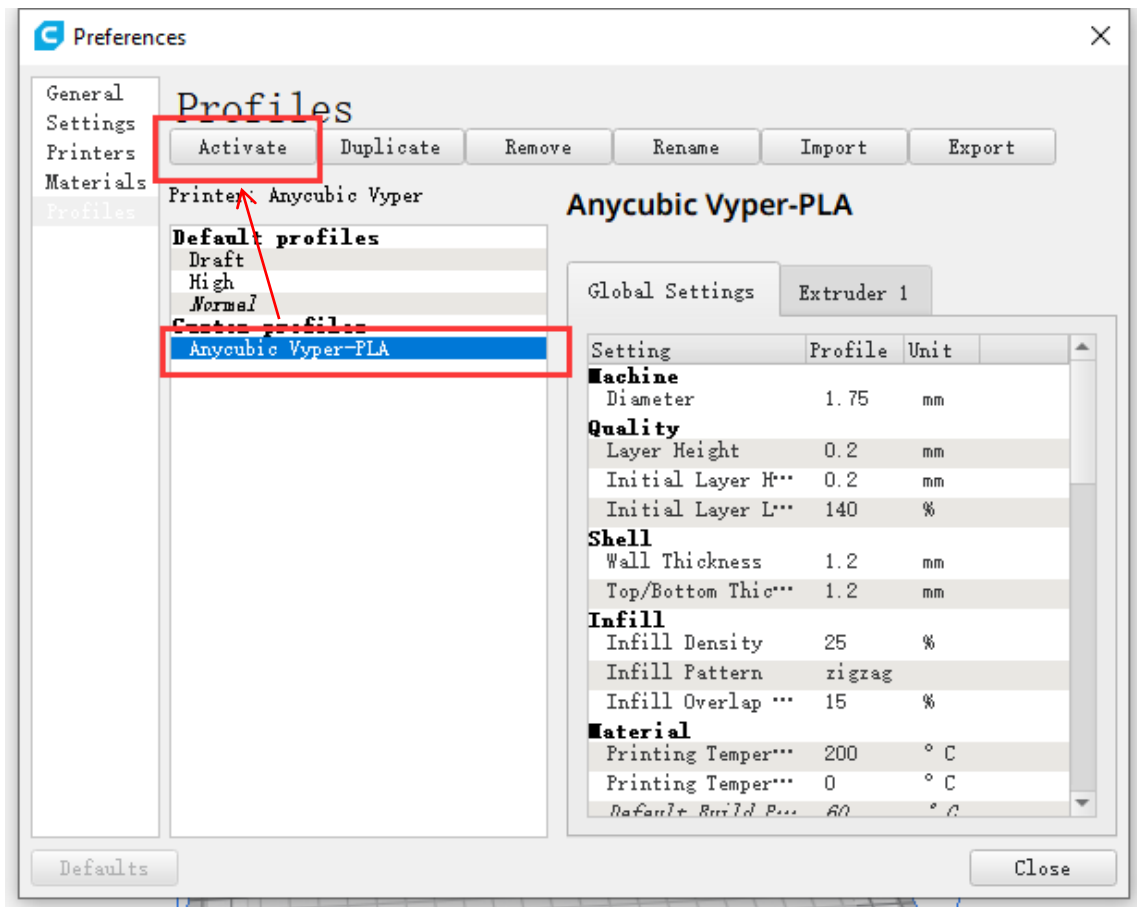

4. Manipulate 3D model in Cura

In the Cura software interface, click on the “File” → “Open File(s)...” to import your own three-dimensional format model (such as .stl file).

Users can “Rotate” “Scale” “Mirror” the model. As shown below:

Introduction to Slicing Software

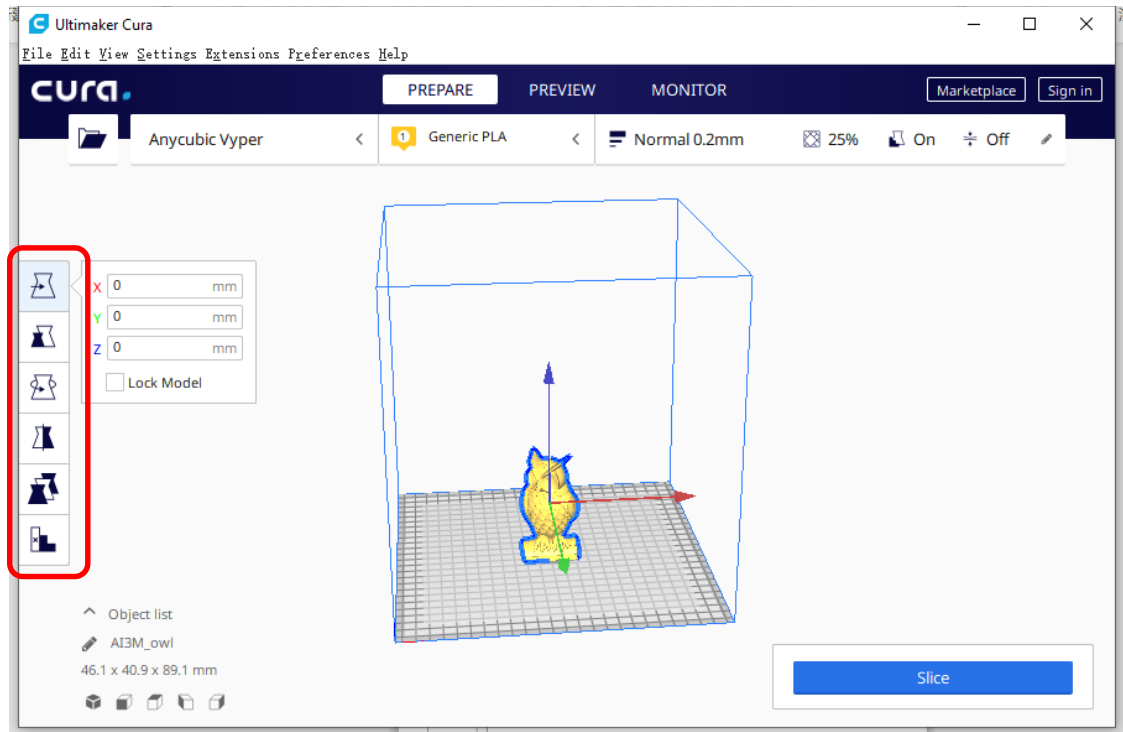

Other operations:

- Position change: left click on the model, hold on and drag the model to move.
- Zoom in/out: scroll the mouse wheel.
- Change viewing angle: right click and move the mouse.

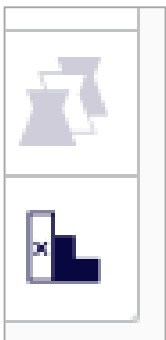

Per Model Settings: When you open multiple models, you can edit a separate slicing configuration for the specified model.

Support Blocker(E): Set the mask area on the model so that the support could not be generated on the set area.

Introduction to Slicing Software

Note: as shown in the figure on the right, the gray color of the model indicates that the model is out of print range.

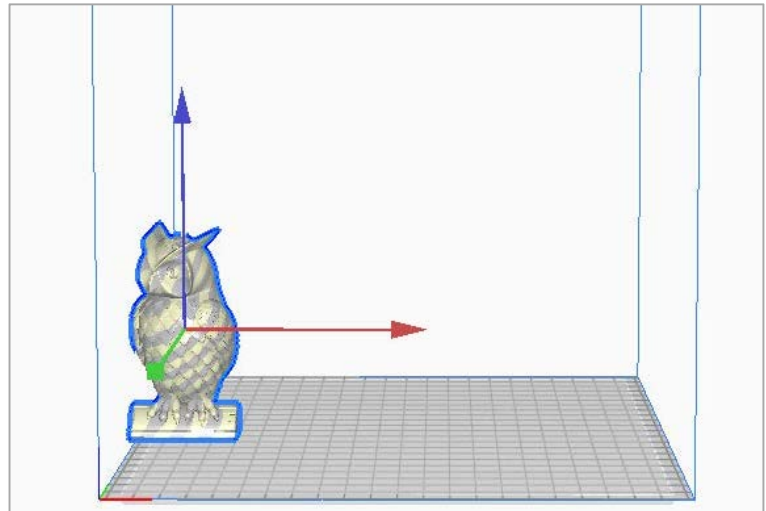

After importing the model, users can customize the printing parameters according to individual needs. But the configuration files that we provide are suggested.

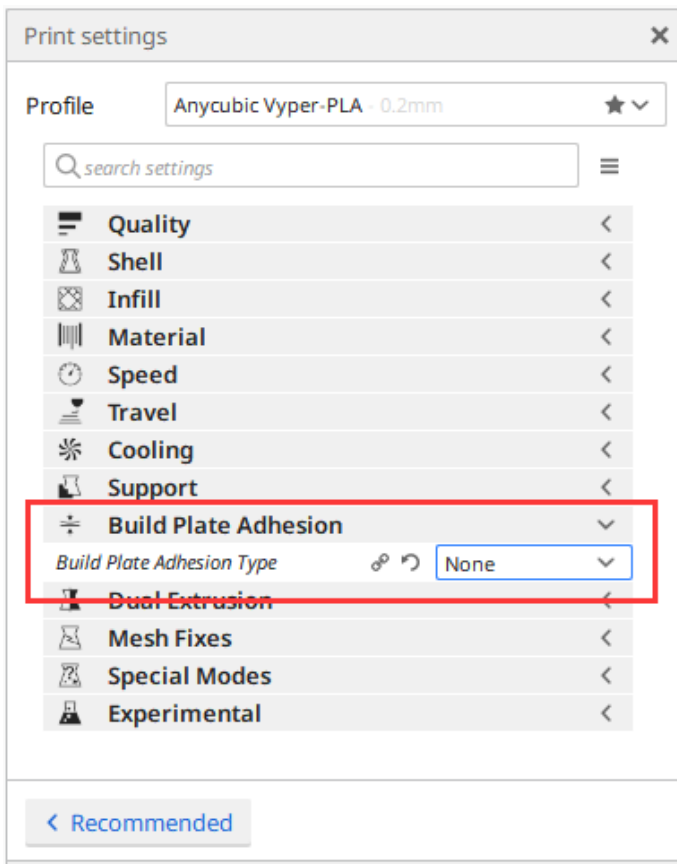

Note: The “Build Plate Adhesion Type” parameter needs to be set to “None” when you print the maximum size model.

Introduction to Slicing Software

5. Slice and preview

After setting the printing parameters, click the "Slice" button in the lower right corner of the software. After the slicing is finished, click the "preview" button to preview the simulated printing effect in the preview view.

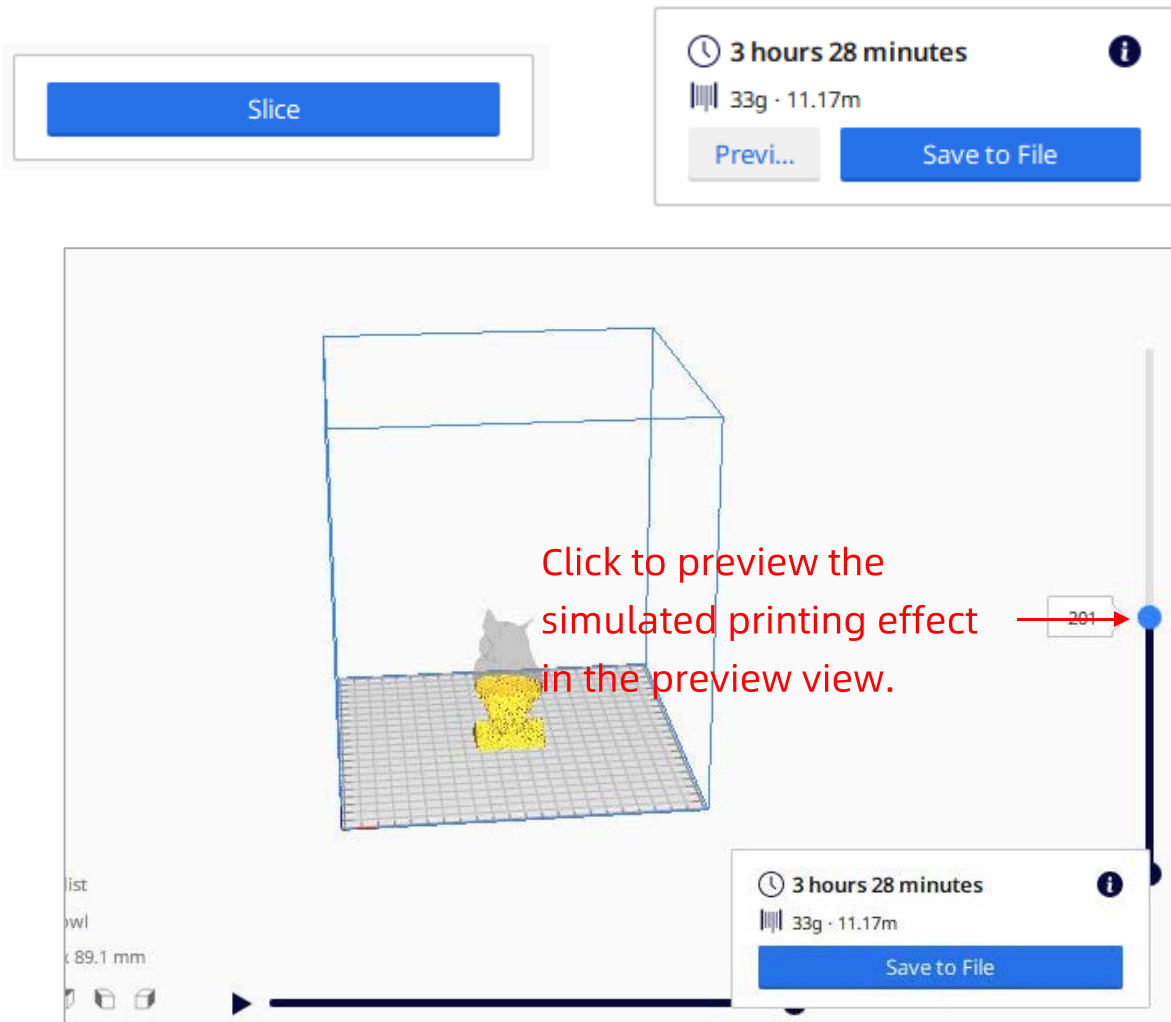

6. Print online

After the parameters have been set up, you can print online via Cura. Click the "MONITOR" on the main interface. If the printer is not connected properly, the interface will be blank.

Introduction to Slicing Software

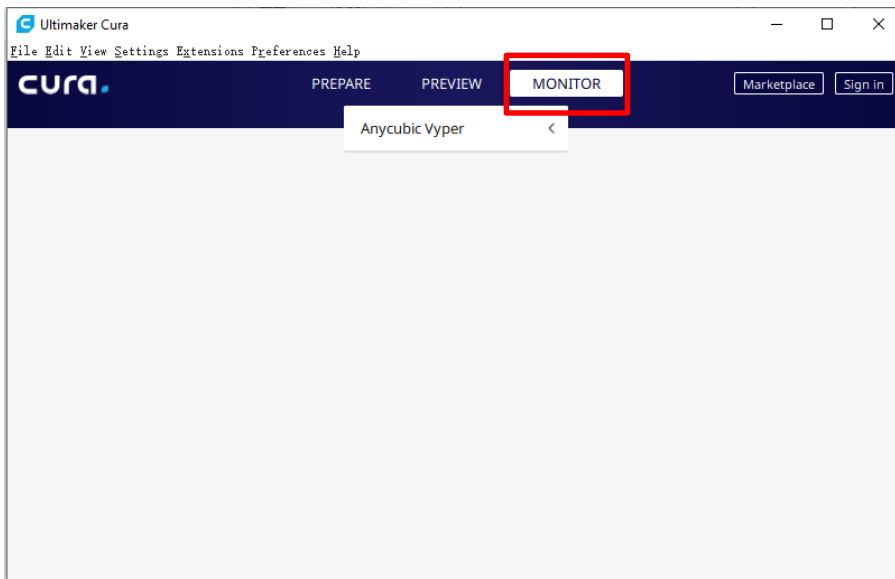

After connecting the data line, Cura will automatically connect to the printer. After waiting for more than ten seconds, the operation panel will be displayed on the right side of the interface. User can control printer through the operation panel. (In the process of printing, do not plug the data line, or it will interrupt the printing)

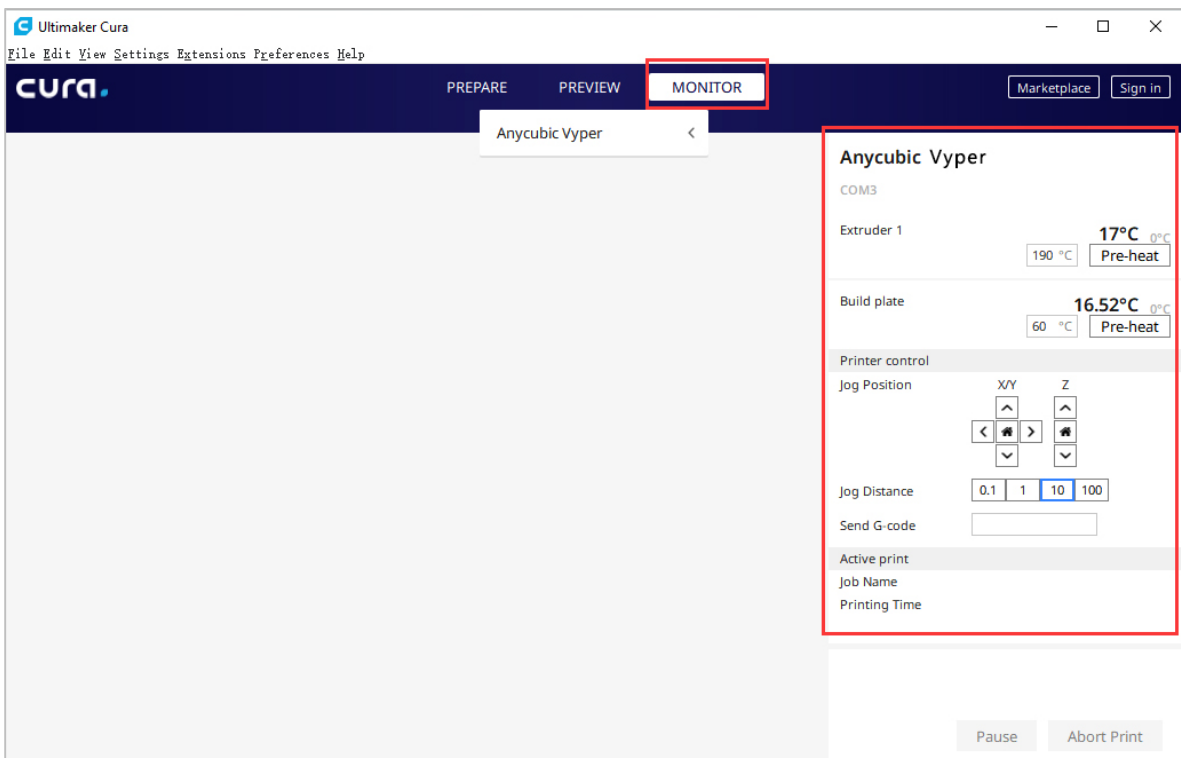

Introduction to Slicing Software

7. Print offline

After slicing, click "save to file" in the lower right corner of Cura software. Save the model GCode file to the **memory card**, and then insert the memory card to the printer and control via the display screen for offline printing.

Note: The file name should only contain English letters, underscore and space. File name contains special characters could not be recognized by the printer. In order to let the printer better recognize the Gcode file in the memory card, you need to back up all the files in the memory card to the computer, and keep the memory card only for the Gcode file, please save all the Gcode files in root directory of the memory card.

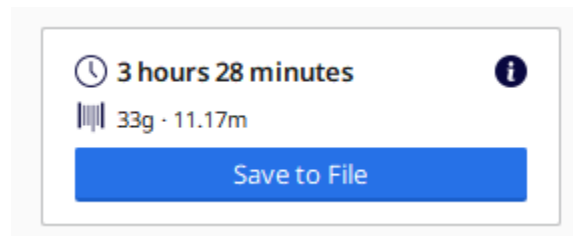

Resume from Outage

Vyper allows resume print after accidentally power loss. Power on the machine when the power loss happens. Click “Continue” if you want to continue the print, or click “Cancel” to give up printing the previous model.



Maintenance

It is necessary to perform routine maintenance to the 3D printer to achieve consistent and quality results.

Some maintenance suggestions are shown as below:

1. Clean the nozzle with a needle under preheating conditions. If the filament residue in the nozzle could not be cleared 100%, please replace the nozzle.
2. Regularly add lubricating oil to smooth rods, linear bearings, lead screws, brass nuts, etc. It can minimize the wear-out failure of those moving parts.
3. Regularly clean the filament residue and dirt on the nozzle, platform, guide rail, motor, fan, etc.
4. Pay attention to the wear conditions of the D-shape wheels. Although they could be used for long time, please replace the D-shape wheels if they have been wore-out.
5. After finishing a printing, clean the printing platform to ensure the adhesion of the bottom layer of the model for next printing.
6. Check the belts regularly and tighten them if necessary.

Troubleshooting

1. Motor shaking or abnormal sound

- ① The corresponding limit switch could not be triggered when home. Check the wirings, and inspect all obstacles by manually moving the corresponding axis.
- ② The motor cable are not connected properly, check each connection and then inspect the cable routing for any fault.
- ③ The motor is damaged.

2. File not printing or memory card failure

- ① Remove the memory card and insert into PC. Open the GCode files using text editor (eg. Notepad), and inspect if GCode is readable or not. If files contains of multiple “ÿÿÿ” symbol, then file has been corrupted. Try to reformat the memory card to FAT32 format and to reload the GCode file.
- ② Memory card is not readable, ensure file name does not contain special characters or change memory card.
- ③ Display screen freeze, reboot the machine and try again.
- ④ The memory card is damaged.

3. No extrusion or extrusion motor knocking

- ① Filament tangles on spool.
- ② Teflon tubing has been tangled, squeezed or bent.
- ③ Ensure that the nozzle temperature has been set to match the filament.
- ④ Nozzle is clogged. Please try to replace it or clean it with a needle.

Troubleshooting

- ⑤ The hotend is not cooled enough.
- ⑥ Print speed is too fast, please reduce the print speed.
- ⑦ The friction between extruder and filament is not strong enough, please increase the extrusion force by rotating the adjustable nut of the extruder.

4. Filament leaking

- ① Nozzle, heating block or throat tube is not tightened properly, try to fix/change it after cooling.

5. Layer shifting

- ① Print head moves too fast, reduce the print speed.
- ② Check X/Y belt and the driving wheel and ensure they are properly installed.
- ③ The model is warping, please refer to item 6 below.
- ④ Drive current is too low, please contact our tech-support.

6. No sticking to the bed and the model is warping

- ① Check if the printing platform is proper leveled.
- ② Set “Initial Layer Height” to 0.2 and “Initial Layer Line Width” to 150 in Cura to improve initial layer adhesion.
- ③ Print too fast at the bottom layer speed, reduce it to ~20mm/s

Troubleshooting

7. Print head moves abnormal

- ① Check if choose the right machine type in slicing software.
- ② Check if any plugins in the slicing software.

8. Print stops halfway

- ① Use print offline mode (memory card) instead of print online via data cable.
- ② Check if the GCode file is corrupted.
- ③ Delete plugins in the GCode file.
- ④ Check if the memory card is damaged.
- ⑤ Power supply voltage is not stable, please print again when the voltage is stable.

9. The print model is difficult to be removed from the platform

- ① Preheat the bottom of the model by hot air and then shovel it with a scraper.
- ② The nozzle is too close to the platform, so the first layer of the model is very sticky with the platform. Make sure the distance between the nozzle and the platform is about the thickness of the paper(~0.1-0.2mm) when leveling, or increase the distance appropriately according to the viscosity of the material.
- ③ Reduce the width of the initial layer line.
- ④ The print speed of the initial layer is too slow, which will cause excessive stickiness between the model and the printing platform. Please increase the print speed of the initial layer.

Troubleshooting

10. The model looks normal but some parts cannot be printed

- ① Special parts such as overhanging parts need to be added with support, etc., and need to be adjusted according to the specific model. It is recommended to preview the print layer to see if it meets the requirements.

11. Drawing is more serious

- ① The retraction distance is insufficient. It should be set larger when slicing.
- ② The retraction speed is too slow. It should be set a bit faster when slicing.
- ③ The printing temperature is too high, which causes the fluidity and viscosity of the filament to be strong. The printing temperature needs to be set a little lower.

12. Nozzle is too low or too high when printing

- ① Nozzle too low, lack of extrusion, the nozzle rub against the platform. Click "Settings" → "Z offset +" to rise the nozzle.
- ② Nozzle too high, large gap, filaments do not even adhere to the platform. Click "Settings" → "Z offset -" to lower the nozzle.

Troubleshooting

Thank you for purchasing **ANYCUBIC** products! Under normal usage and service, the products and its parts have a warranty period up to one year. Please visit **ANYCUBIC** support center (support.anycubic.com/en) to report any issue with **ANYCUBIC** products. Our professional after-sale service team would respond within 24 hours and help you to solve the issues.